

VIEW Q
REAR SIDE
SCALE: 1/15

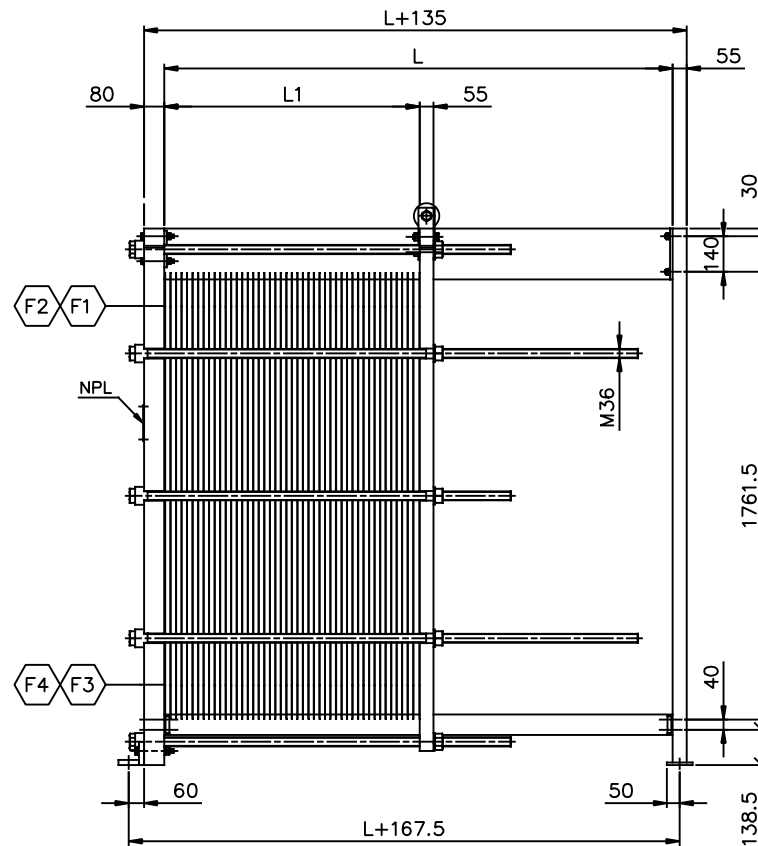

ELEVATION
SCALE: 1/15

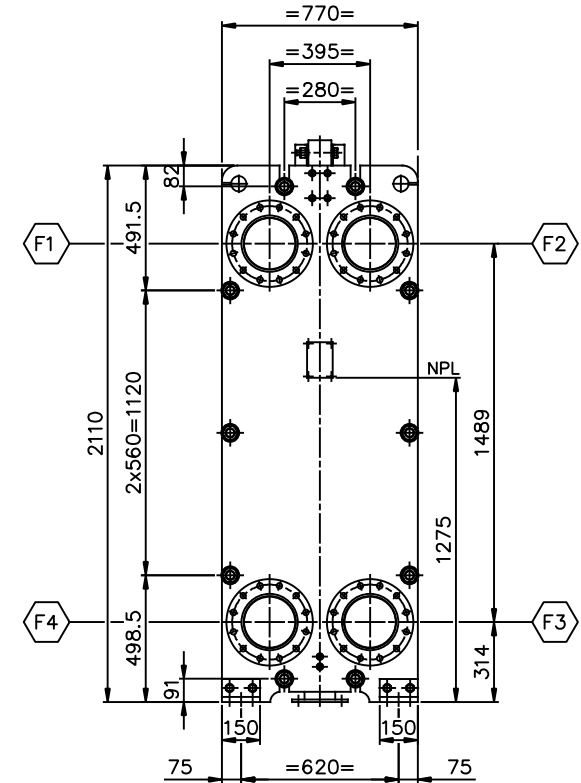

VIEW P
FRONT SIDE
SCALE: 1/15

Dimensions without tolerance:	Designed by O.AKSAK	Approved by ARES	Rev. no. 0	Revision Text FOR APPROVAL	Format A1	Scale 1:15+VAR.
	Description: PHE MODEL: A8L PN16 L=600 ÷ 2000 MM GENERAL ARRANGEMENT					
ISOprojektion 			Rev.date 12-08-'12	Rev.by HE	Drawing no. A8L-10016-01	Sheet 1 OF 1