

VIEW Q
REAR SIDE
SCALE: 1/5

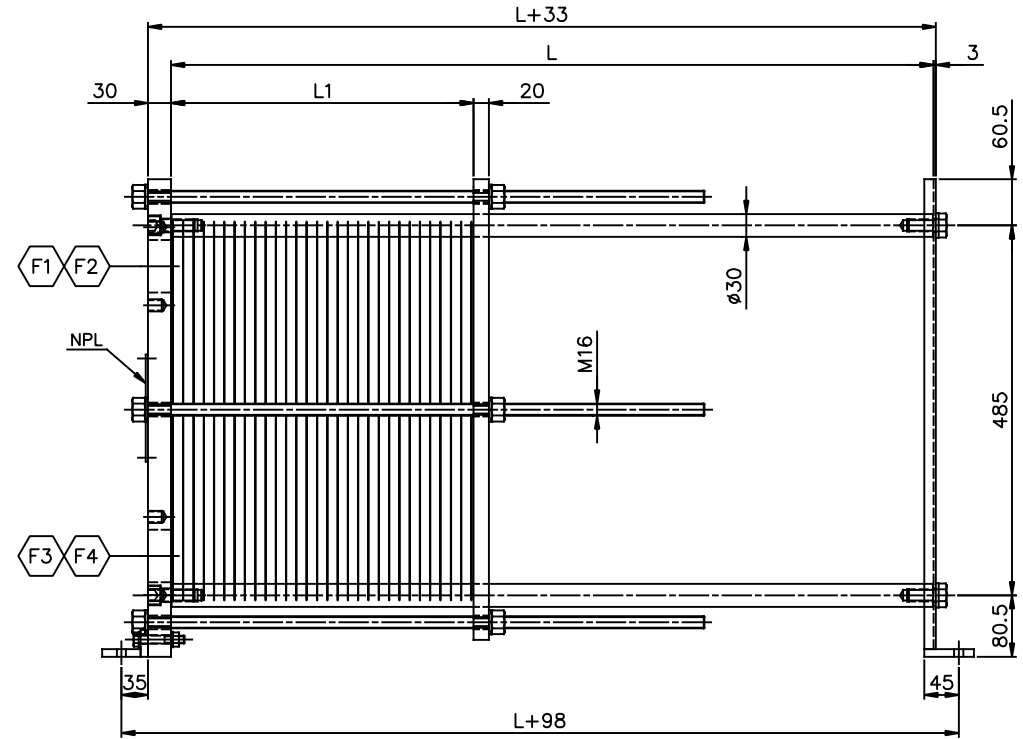

ELEVATION
SCALE: 1/5

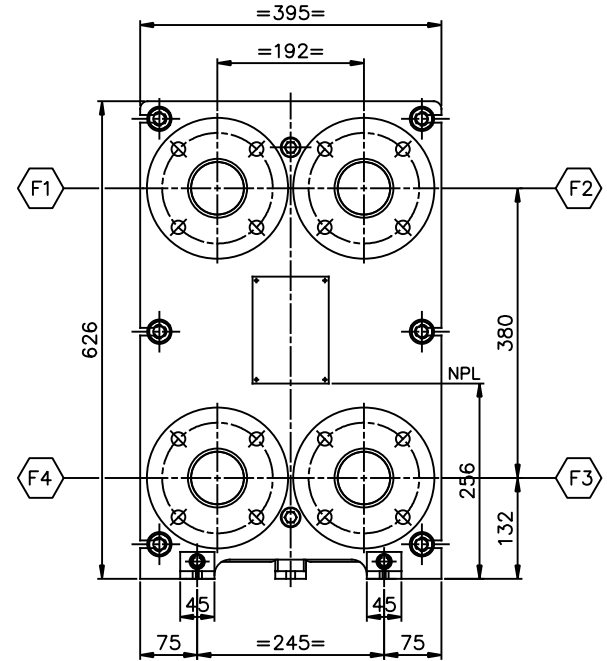

VIEW P
FRONT SIDE
SCALE: 1/5

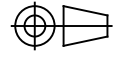
Dimensions without tolerance:	Designed by	Approved by	Rev. no.	Revision Text	Format	Scale
	O.AKSAK	ARES	0	FOR APPROVAL	A1	1: 5+VAR.
ISOprojektion	Description:					
	PHE MODEL: A3S PN10 L=100÷1000 MM GENERAL ARRANGEMENT					
	Rev.date	Rev.by	Drawing no.	Sheet		
	25-06-'12	HE	A3S-10010-01	1 OF 1		

