

VIEW Q
REAR SIDE
SCALE: 1/7.5

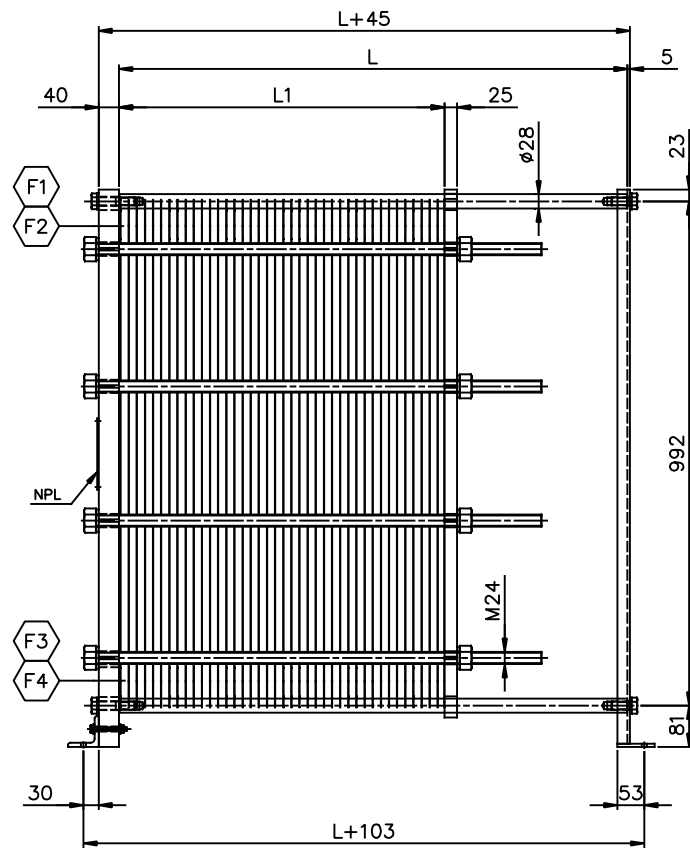

ELEVATION
SCALE: 1/7.5

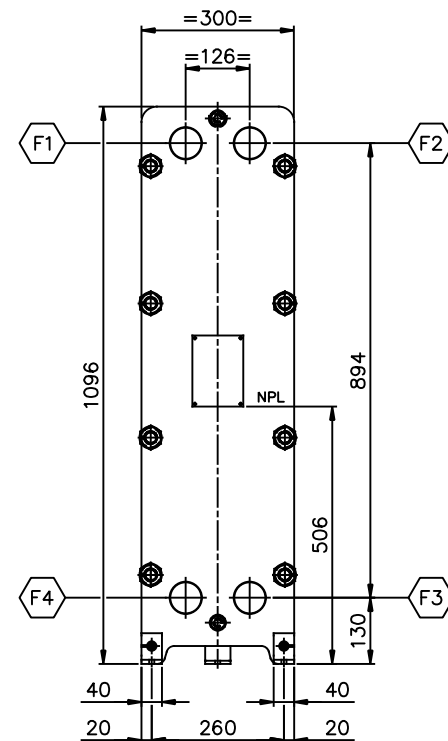

VIEW P
FRONT SIDE
SCALE: 1/7.5

Dimensions without tolerance:	Designed by O.AKSAK	Approved by ARES	Rev. no. 0	Revision Text FOR APPROVAL	Format A1	Scale 1:7.5+VAR
	Description: PHE MODEL: A2L PN25 L=100 ÷ 1000 MM GENERAL ARRANGEMENT					
ISO projektion 			Rev. date	Rev. by	Drawing no.	Sheet
			18-06-'12	ARES	A2L-10025-01	1 OF 1