

VIEW Q
REAR SIDE
SCALE: 1/20

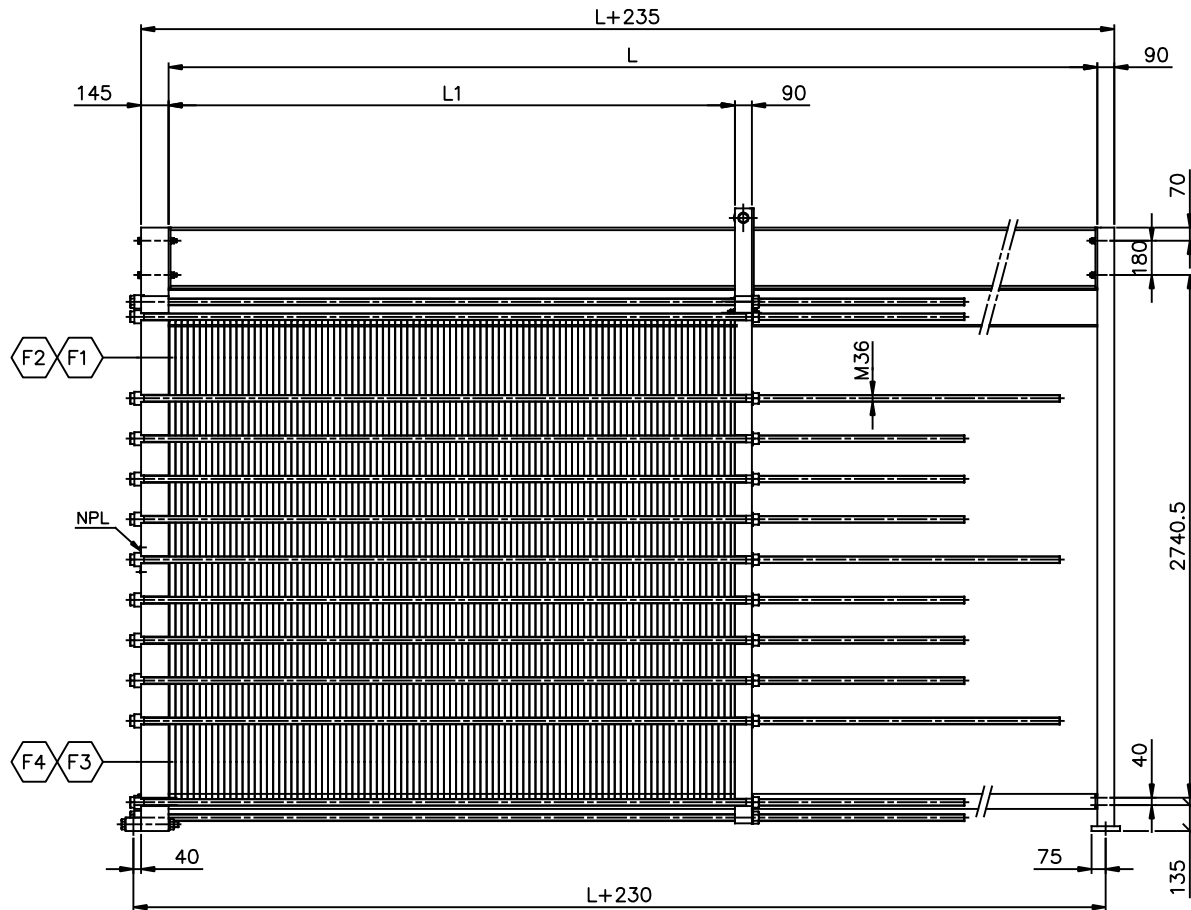

ELEVATION
SCALE: 1/20

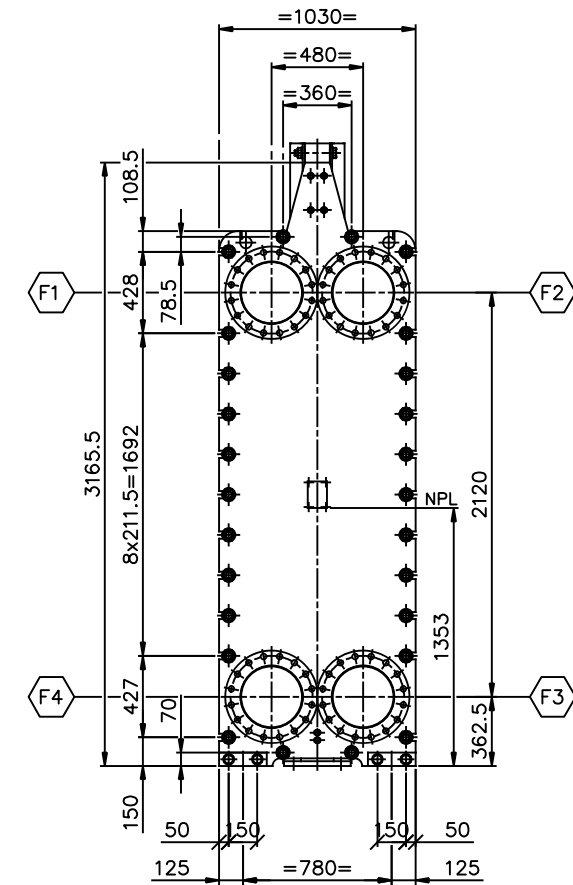

VIEW P
FRONT SIDE
SCALE: 1/20

Dimensions without tolerances:	Designed by O.AKSAK	Approved by ARES	Rev. no. 0	Revision Text FOR APPROVAL	Format A1	Scale 1:20+VAR.
	Description: PHE MODEL: A12L PN25 L=5000 ÷ 6000 MM GENERAL ARRANGEMENT					
ISOprojektion 			Rev.date 02-09-'12	Rev.by HE	Drawing no. A12L-30025-01	Sheet 1 OF 1