

VIEW Q
REAR SIDE
SCALE: 1/20

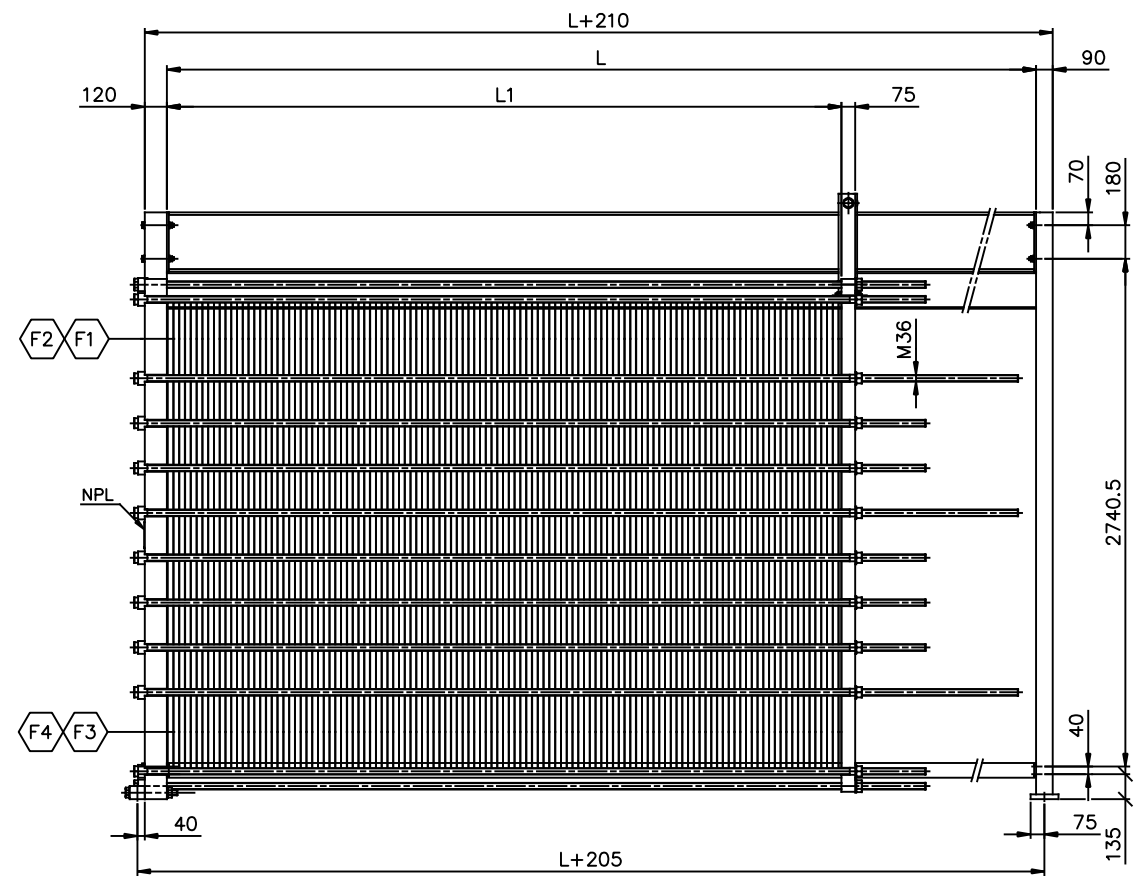

ELEVATION
SCALE: 1/20

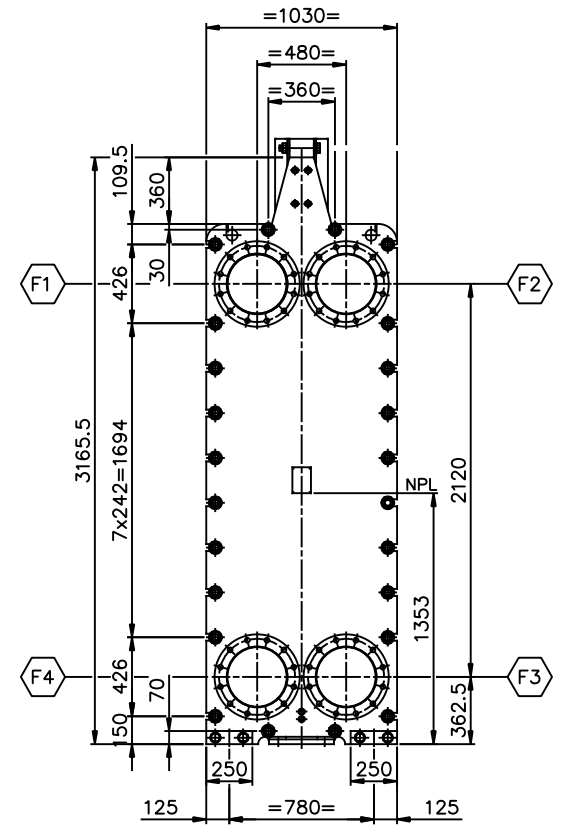

VIEW P
FRONT SIDE
SCALE: 1/20

Dimensions without tolerance:	Designed by	Approved by	Rev. no.	Revision Text	Format	Scale
	O.AKSAK	ARES	0	FOR APPROVAL	A1	1:20+VAR.
ISOprojektion	Description:					
	PHE MODEL: A12L PN16 L=5000 ÷ 6000 MM GENERAL ARRANGEMENT					
	Rev.date	Rev.by	Drawing no.	Sheet		
	02-09-'12	HE	A12L-30016-01	1 OF 1		

